

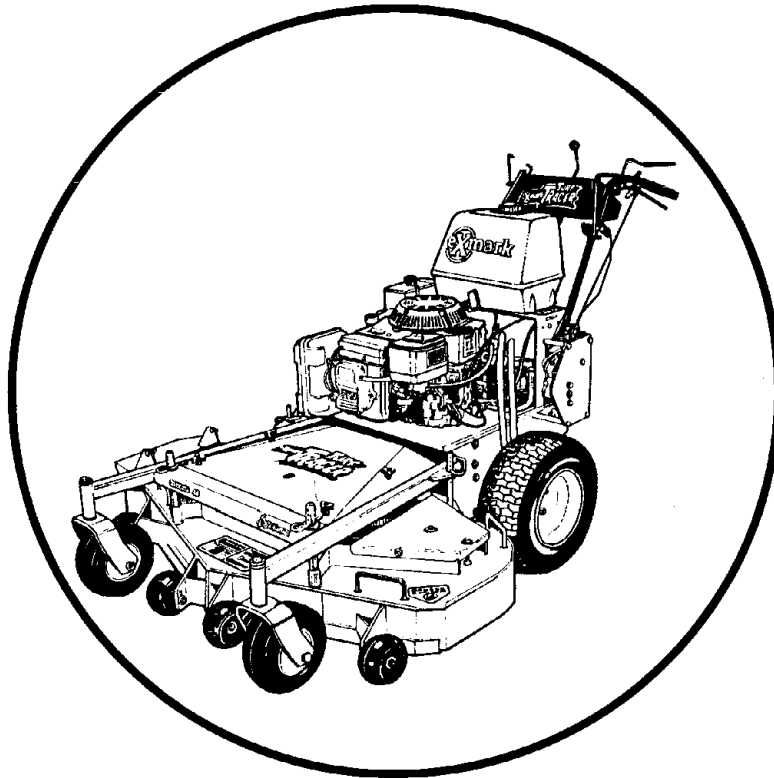

For Serial Nos.  
160,000 and Higher

# TURF TRACER HP



## Parts Manual

**CONGRATULATIONS** on the purchase of your new Exmark mower. This product has been carefully designed and manufactured to give you a maximum amount of dependability and years of trouble-free operation.

If additional information is needed, or should you require trained mechanic service, contact your authorized Exmark equipment dealer or distributor.

If you need to order replacement parts from your dealer, always give the model number and serial number of your mower as well as the part number, description and quantity of the part needed.

The Serial No. plate is located on the top front engine frame on the right hand side of the machine.

For ease of ordering and reference, we suggest that you record the information requested in the following identification table.

Model No. \_\_\_\_\_

Serial No. \_\_\_\_\_

Date Purchased \_\_\_\_\_

Purchased From \_\_\_\_\_

Paste Label From  
Literature Packet Here



# EXMARK PARTS PLUS® PROGRAM

EFFECTIVE DATE: September 1, 1995

## Program

If your Exmark dealer does not have the Exmark part in stock, Exmark will get the parts to the dealer the next business day or the part will be FREE\* Guaranteed!!

## *How the Program Works*

1. If dealer does not have part in stock for a "down" unit at the time of request by customer, the dealer contacts his distributor by 1:00 p.m., local time, and requests Exmark Parts Plus® shipment of six (6) line items or less.
2. Distributor ships part(s) to dealer or customer, as requested by dealer, same day, overnight UPS. Distributor bills dealer for part and freight charges where applicable.
3. If distributor does not have the part(s) in stock to satisfy Exmark Parts Plus® order, he contacts Exmark by 3:00 p.m., central time, with an Exmark Parts Plus® order of six (6) line items or less.
4. If order is received by 3:00 p.m. central time, Exmark ships part(s) direct to dealer or customer, as requested by distributor, same day, overnight UPS. Exmark bills the distributor for parts and shipping charges, where applicable.
5. The customer pays for the part and freight if it is shipped under the Exmark Parts Plus® and if it arrive in accordance to the program.
6. Who pays for the part and freight if it fails to arrive overnight in accordance to the program?
  - A. Under any circumstance the customer does not pay.
  - B. If the part does not arrive overnight due to:
    1. The dealer not submitting the Exmark Parts Plus® order to his Exmark distributor by 1:00 p.m., the dealer pays for the part and freight.
    2. The Distributor being unable to ship the part the same day or not submitting the Exmark Parts Plus® order to Exmark by 3:00 p.m., central time, the Distributor pays for the part and freight.
    3. Exmark being unable to ship the part and the Exmark parts order is received by 3:00 p.m., central time, Exmark pays for the part and freight.
    4. If the part does not arrive overnight due to the shipper (UPS), the shipper pays for the freight and Exmark pays for the part.

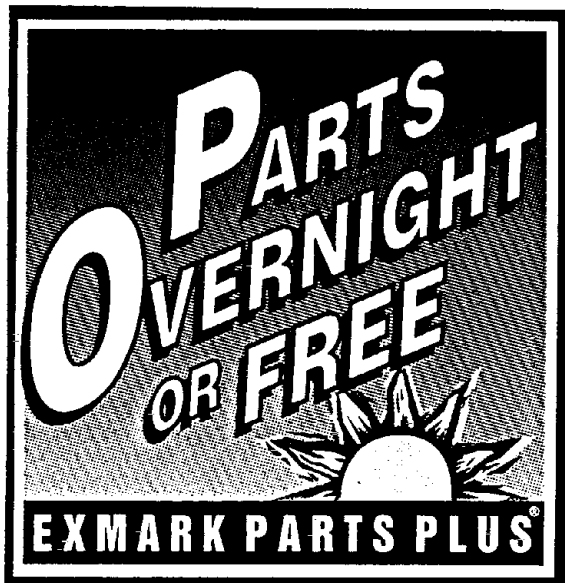

**The following restrictions apply** -- The Exmark Parts Plus® Program is available only through participating Exmark Dealers and applies only to orders submitted on this program Monday through Thursday. UPS has initiated a Saturday delivery program to many areas of the continental United States and can be requested for an overnight shipment on Friday to be delivered Saturday. The next day air charge, plus the Saturday delivery fee will be the responsibility of the purchaser. Exmark Mfg. will assume no responsibility for Saturday delivery shipments. To qualify, all Exmark Parts Plus® orders must be received by Exmark by 3:00 p.m., central time. Orders must be six (6) line items or less. Exclusions from the Exmark Parts Plus® Program are: Any wholegood or accessory in its entirety, engines and engine replacement parts, 5-speed Peerless transmissions and 5-speed transaxles, hydraulic or hydrostatic wheel motors, cutter decks and engine decks or any item exceeding United Parcel Service size and weight restrictions.

Due to UPS restrictions, aerosol spray paint is considered a hazardous material and cannot be shipped via UPS next day or Second Day Air.

Exmark Manufacturing stocks a limited supply of parts for transaxles, pumps and wheel motors. These parts can be ordered for Next Day Air shipment but will not be guaranteed per the Parts Plus Program.



**READ OPERATOR'S MANUAL BEFORE  
OPERATING OR SERVICING EXMARK EQUIPMENT.**

## **TABLE OF CONTENTS**

<b><u>Description</u></b>	<b><u>Page</u></b>
Decals.....	14-15
Engine Deck Group.....	8-10
52" Mower Deck .....	6-7
48" Mower Deck .....	4-5
Hydraulics Group .....	11
36" Mower Deck .....	2-3
Upper Handles & Controls .....	12-13
Wiring Diagrams .....	16-17

## 36" MOWER DECK

Ref. No.	Part No.	Description	Qty. Req'd.
1	414386	Shield, belt w/decals .....	1
	413098	Shield, belt .....	1
2	323385	Knob, belt shield .....	4
3	323417	Washer, belt cover.....	4
4	414309	Support weldmt w/bushings &decals ....	1
	412108	Support weldmt .....	1
5	★ 413425	Spacer, Front Deck Support .....	2
6	513336	Bushing, deck support .....	2
7	806007	Hairpin, Cotter .....	2
8	303164	Spacer, Blade Drive .....	2
9	613203	Link, Deck Support .....	2
10	800293	Screw,Hex Cap 3/8-16x1-1/4 .....	20
11	804525	Nut, Reg Hex 3/8-24 .....	2
12	808507	Ring, Retaining .....	2
13	806006	Hairpin, Cotter .....	2
14	811001	Zerk, straight 1/8 .....	2
15	800292	Screw, Hex Cap 3/8-16x1 .....	2
16	805006	Washer, 3/8 heavy spring.....	2
17	373034	Washer, Swivel .....	3
18	303514	Bearing, Flange .....	4
19	804509	Nut, Reg Hex 1/2-13 .....	2
20	805008	Washer, Lock Hlcl Spg 1/2 Reg .....	2
21	522143	Caster weldmt .....	2
22	800334	Screw, Hex Cap 1/2-13x6 .....	2
23	809007	Nut, Whizlock 3/8-16 .....	12
24	303327	Washer, Disc Spring 3/8 .....	11
25	513648	Tire & Wheel Assembly .....	2
	513807	Wheel & Hub .....	2
	513808	Tire, 9x3.50-4 4-ply .....	2
	513809	Roller Bearing .....	2
	513810	Bushing .....	4
26	513547	Spacer .....	2
27	412238	Chute weldmt, discharge .....	1
28	413094	Belt, deck drive .....	1
29	633151	Spring, extension .....	1
30	804257	Nut, Nyloc 3/8-16 .....	13
31	805260	Washer, Flat Std 3/8 .....	1
32	513034	Pivot, Bearing .....	2
33	811008	Zerk, 90 degree 1/4-28 .....	1
34	803016	Bolt, Hex Whizlock 3/8-16x1 .....	1
35	805259	Washer, Flat 3/8 SAE .....	2
36	413099	Pulley, Idler .....	1

Ref. No.	Part No.	Description	Qty. Req'd.
37	412134	Arm, weldmt .....	1
	414144	Arm, Weldmt w/bushings .....	1
38	603384	Bushing, Idler Pivot .....	1
39	613098	Pulley, Idler .....	1
40	413113	Bushing, Idler .....	1
41	804256	Nut, Nylock 5/16-18 .....	2
42	809001	Nut, Whizlock 5/16-18 .....	3
43	800273	Screw, Hex Cap 5/16-18x1 .....	2
44	603001	Rod, Deck Support .....	2
45	806332	Rollpin, 1/4x1-1/2 .....	2
46	800270	Screw, Hex Cap 5/16-18x5/8 .....	3
47	414383	Deck weldmt w/decals, discharge baffle & support rods .....	1
	412104	Deck weldmt .....	1
48	522480	Baffle, discharge .....	1
49	613204	Ball Joint .....	2
50	800299	Screw, Hex Cap 3/8-16x2-3/4 .....	1
51	800805	Screw, Hex Cap 3/8-16x3-1/2 G8.....	1
52	633482	Blade, 18.00 Notched Air Foil .....	2
	613251	Blade, 18.00 Solid Air Foil .....	2
	● 633484	Blade, 18.00 Mulching .....	2
	633485	Blade, 18.00 Low Lift .....	2
53	513208	Washer, Spring disc .....	4
54	800340	Screw, Hex Cap 5/8-11x1 .....	2
55	603299	Roller, antiscalp .....	1
56	603602	Bushing, roller .....	1
57	800807	Screw, Hex Cap 3/8-16x4 G8 .....	1
58	603050	Bushing Spacer .....	2
59	804510	Nut, Reg Hex 5/8-18 .....	2
60	413424	Sheave w/Hub .....	2
61	800295	Screw, Hex Cap 3/8-16x1-3/4 .....	2
62	513016	Bearing .....	4
63	614213	Link, Assembly .....	2
64	323532	Housing, Spindle .....	2
65	323528	Spacer, Bearing .....	2
66	633573	Gaurd, Bearing-Bottom .....	2
67	808502	Ring, Snap .....	2
68	807268	Key, machine .....	2
69	413330	Shaft, Spindle .....	2
70	414335	Housing, Cutter Assembly .....	2
71	611216	Kit, Link Assembly .....	2
72	323533	Spacer .....	2
73	634619	Housing w/Brgs, Spacer & Ring .....	2

● Requires installation of Micro-Mulch accessory for proper mulching. Mulch kit P/N MK363(36")

★ Replace both sides if unit is equipped with 3/16" thick washers.

Exmark red touch up spray paint - P/N 850337

# 36" MOWER DECK

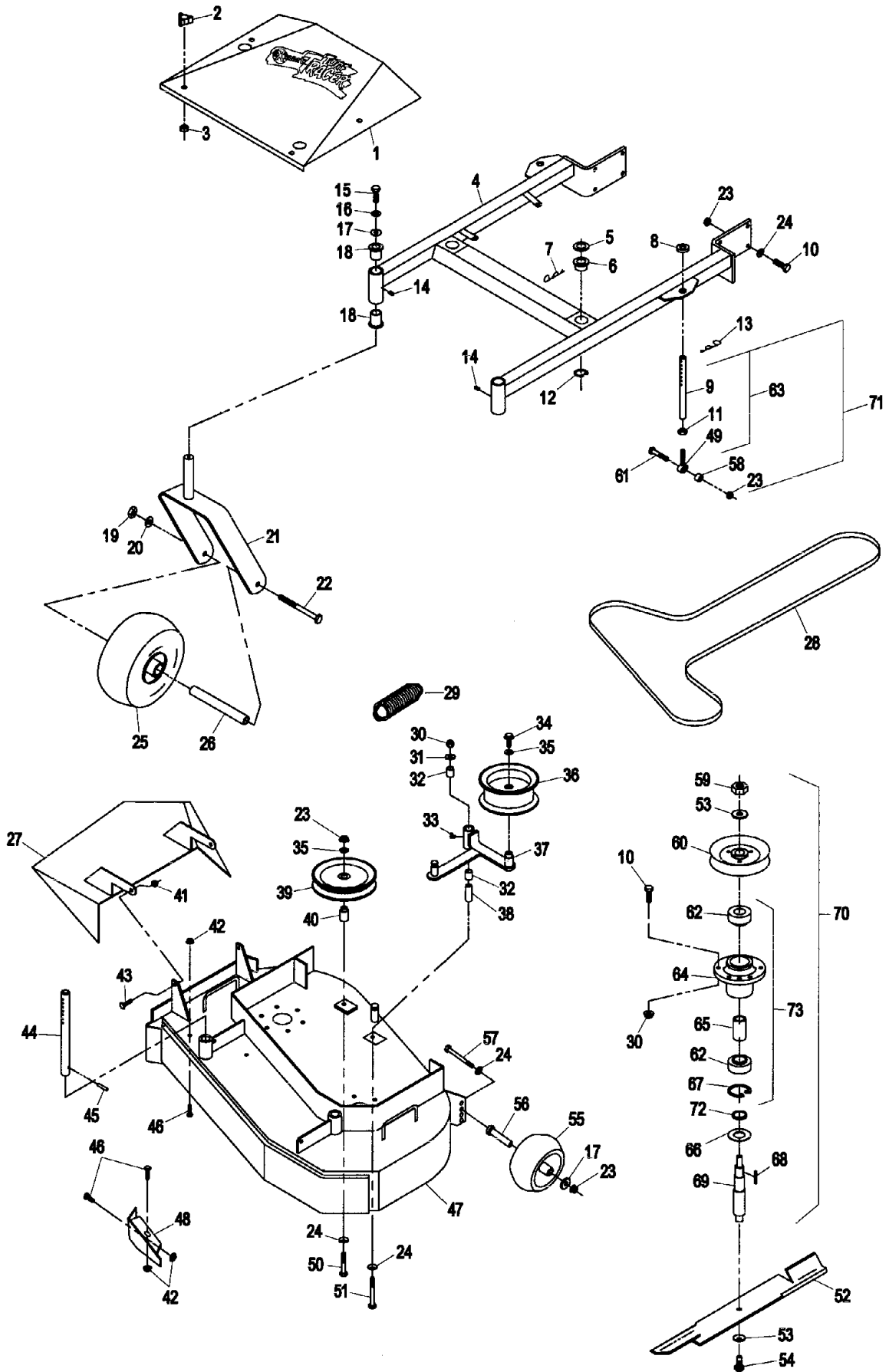

## 48" MOWER DECK

Ref. No.	Part No.	Description	Qty. Req'd.
1	414387	Shield, belt w/decals .....	1
	413101	Shield, belt .....	1
2	323385	Knob, belt shield .....	4
3	323417	Washer, belt cover.....	4
4	414310	Support weldmt w/bushings &decals ....	1
	412110	Support weldmt .....	1
5	★ 413425	Spacer, Front Deck Support .....	2
6	513336	Bushing, deck support .....	2
7	806007	Hairpin, Cotter .....	2
8	303164	Spacer, Blade Drive .....	2
9	613203	Link, Deck Support .....	2
10	800293	Screw, Hex Cap 3/8-16x1-1/4 .....	26
11	804525	Nut, Reg Hex 3/8-24 .....	2
12	808507	Ring, Retaining .....	2
13	806006	Hairpin, Cotter .....	2
14	811001	Zerk, straight 1/8 .....	2
15	800292	Screw, Hex Cap 3/8-16x1 .....	2
16	805006	Washer, 3/8 heavy spring.....	2
17	373034	Washer, Swivel .....	6
18	303514	Bearing, Flange .....	4
19	804509	Nut, Reg Hex 1/2-13 .....	2
20	805008	Washer, Lock Hlcl Spg 1/2 Reg .....	2
21	522143	Caster weldmt .....	2
22	800334	Screw, Hex Cap 1/2-13x6 .....	2
23	809007	Nut, Whizlock 3/8-16 .....	16
24	303327	Washer, Disc Spring 3/8 .....	15
25	513648	Tire & Wheel Assembly .....	2
	513807	Wheel & Hub .....	2
	513808	Tire, 9x3.50-4 4-ply .....	2
	513809	Roller Bearing .....	2
	513810	Bushing .....	4
26	513547	Spacer .....	2
27	522478	Chute weldmt, discharge .....	1
28	413093	Belt, deck drive .....	1
29	633151	Spring, extension .....	1
30	804257	Nut, Nyloc 3/8-16 .....	19
31	805260	Washer, Flat Std 3/8 .....	1
32	513034	Pivot, Bearing .....	2
33	811008	Zerk, 90 degree 1/4-28 .....	1
34	803016	Bolt, Whizlock 3/8-16x1 .....	1
35	805259	Washer, Flat 3/8 SAE .....	3
36	413099	Pulley, Idler .....	1
37	412394	Arm, weldmt .....	1
	414398	Arm, Weldmt w/bushings .....	1

Ref. No.	Part No.	Description	Qty. Req'd.
38	603384	Bushing, Idler Pivot .....	1
39	613098	Pulley, Idler .....	2
40	413113	Bushing, idler .....	2
41	804256	Nut, Nylock 5/16-18 .....	8
42	809001	Nut, Whizlock 5/16-18 .....	5
43	800273	Screw, Hex Cap 5/16-18x1 .....	2
44	603001	Rod, Deck Support .....	2
45	806332	Rollpin, 1/4x1-1/2 .....	2
46	800270	Screw, Hex Cap 5/16-18x5/8 .....	3
47	414384	Deck weldmt w/decals, discharge baffle & support rods .....	1
	412106	Deck weldmt .....	1
48	522480	Baffle, discharge .....	1
49	613204	Ball Joint .....	2
50	800299	Screw, Hex Cap 3/8-16x2-3/4 .....	2
51	800805	Screw, Hex Cap G8 3/8-16x3-1/2 .....	1
52	323515	Blade, 16.25 Notched Air Foil .....	3
	413438	Blade, 16.25 Solid Air Foil .....	3
	● 403148	Blade, 16.25 mulching .....	3
	403149	Blade, 16.25 low lift .....	3
53	513208	Washer, Spring disc .....	6
54	800340	Screw, Hex Cap 5/8-11x1 .....	3
55	603299	Roller, antiscalp .....	4
56	603602	Bushing, roller .....	4
57	800807	Screw, Hex Cap G8 3/8-16x4 .....	4
58	603050	Bushing Spacer .....	2
59	804510	Nut, Reg Hex 5/8-18 .....	3
60	413424	Sheave w/Hub .....	3
61	800295	Screw, Hex Cap 3/8-16x1-3/4 .....	2
62	513016	Bearing .....	6
63	614213	Link, Assembly .....	2
64	323532	Housing, Spindle .....	3
65	323528	Spacer, Bearing .....	3
66	633573	Gaurd, Bearing-Bottom .....	3
67	808502	Ring, Snap .....	3
68	807268	Key, machine .....	3
69	413330	Shaft, Spindle .....	3
70	414335	Housing, Cutter Assembly .....	3
71	523471	Shield, Belt .....	2
72	805258	Washer, Flat Std 5/16 .....	6
73	800017	Bolt, Hex Tap 5/16-18x3 1/4 .....	2
74	611216	Kit, Link Assembly .....	2
75	323533	Spacer .....	3
76	634619	Housing w/Brgs, Spacer & Ring .....	3

- Requires installation of Micro-Mulch accessory for proper mulching. Mulch kit P/N MK483(48")
- ★ Replace both sides if unit is equipped with 3/16" thick washers.  
Exmark red touch up spray paint - P/N 850337

# 48" MOWER DECK

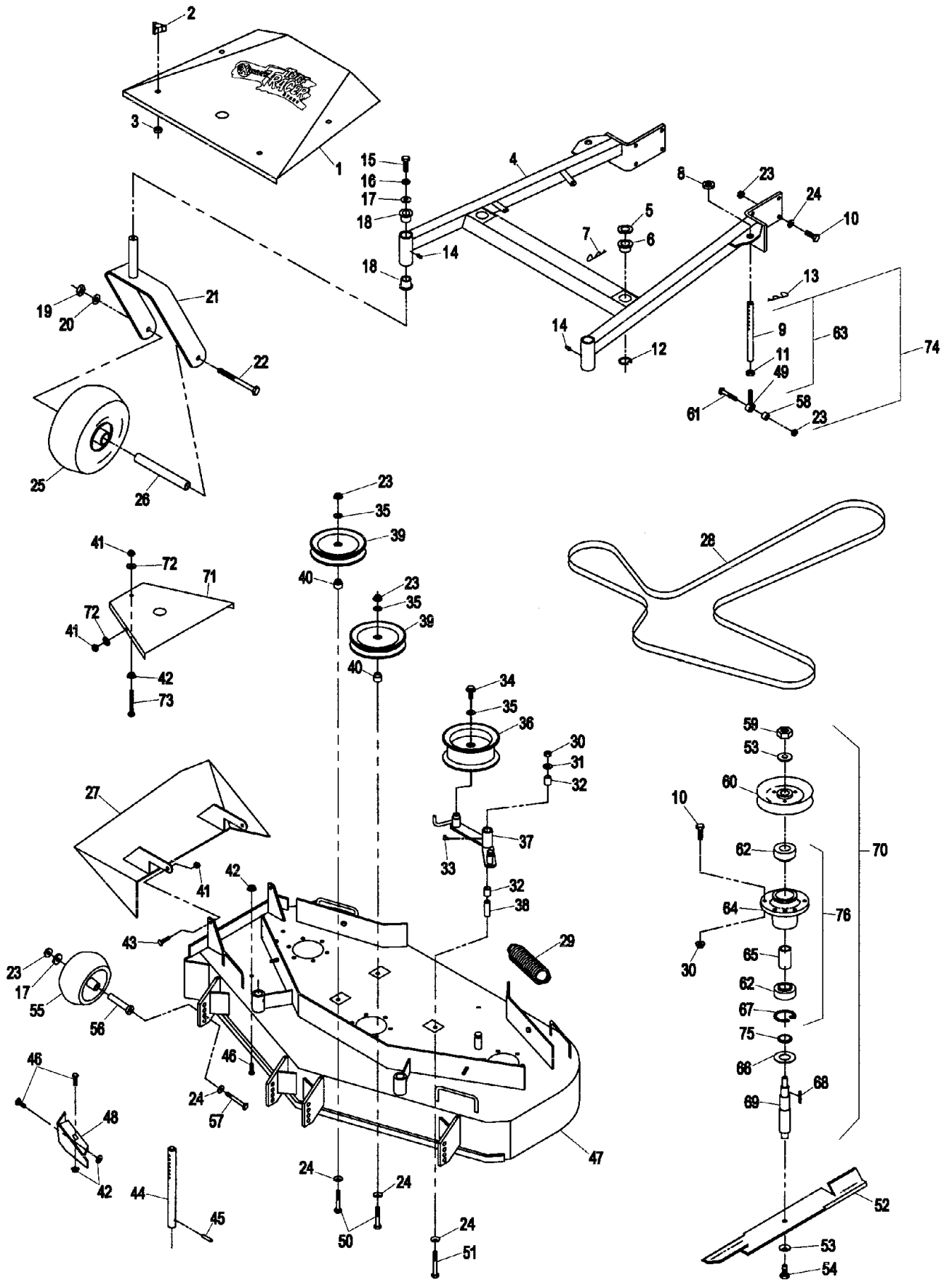

## 52" MOWER DECK

Ref. No.	Part No.	Description	Qty. Req'd.
1	414388	Shield, belt w/decals .....	1
	413303	Shield, belt .....	1
2	323385	Knob, belt shield .....	5
3	323417	Washer, belt cover.....	5
4	414311	Support weldmt w/bushings &decals ....	1
	412317	Support weldmt .....	1
5	★ 413425	Spacer, Front Deck Support .....	2
6	513336	Bushing, deck support .....	2
7	806007	Hairpin, Cotter .....	2
8	303164	Spacer, Blade Drive .....	2
9	613203	Link, Deck Support .....	2
10	800293	Screw, Hex Cap 3/8-16x1-1/4 .....	26
11	804525	Nut, Reg Hex 3/8-24 .....	2
12	808507	Ring, Retaining .....	2
13	806006	Hairpin, Cotter .....	2
14	811001	Zerk, straight 1/8 .....	2
15	800292	Screw, Hex Cap 3/8-16x1 .....	2
16	805006	Washer, 3/8 heavy spring.....	2
17	373034	Washer, Swivel .....	8
18	303514	Bearing, Flange .....	4
19	804509	Nut, Reg Hex 1/2-13 .....	2
20	805008	Washer, Lock Hlcl Spg 1/2 Reg .....	2
21	522143	Caster weldmt .....	2
22	800334	Screw, Hex Cap 1/2-13x6 .....	2
23	809007	Nut, Whizlock 3/8-16 .....	18
24	303327	Washer, Disc Spring 3/8 .....	17
25	513648	Tire & Wheel Assembly .....	2
	513807	Wheel & Hub .....	2
	513808	Tire, 9x3.50-4 4-ply .....	2
	513809	Roller Bearing .....	2
	513810	Bushing .....	4
26	513547	Spacer .....	2
27	602571	Chute weldmt, discharge .....	1
28	413308	Belt, deck drive .....	1
29	633151	Spring, extension .....	1
30	804257	Nut, Nyloc 3/8-16 .....	27
31	805260	Washer, Flat Std 3/8 .....	9
32	513034	Pivot, Bearing .....	2
33	811008	Zerk, 90 degree 1/4-28 .....	1
34	803016	Bolt, Whizlock 3/8-16x1 .....	1
35	805259	Washer, Flat 3/8 SAE .....	3
36	413099	Pulley, Idler .....	1

Ref. No.	Part No.	Description	Qty. Req'd.
37	412394	Arm, weldmt .....	1
	414398	Arm, Weldmt w/bushings .....	1
38	603384	Bushing, Idler Pivot .....	1
39	613098	Pulley, Idler .....	2
40	413113	Bushing, Idler .....	2
41	804256	Nut, Nylock 5/16-18 .....	2
42	809001	Nut, Whizlock 5/16-18 .....	4
43	800273	Screw, Hex Cap 5/16-18x1 .....	2
44	603001	Rod, Deck Support .....	2
45	806332	Rollpin, 1/4x1-1/2 .....	2
46	800270	Screw, Hex Cap 5/16-18x5/8 .....	4
47	414385	Deck weldmt w/decals, discharge baffle & support rods .....	1
	412313	Deck weldmt .....	1
48	602913	Baffle, discharge .....	1
49	613204	Ball Joint .....	2
50	800299	Screw, Hex Cap 3/8-16x2-3/4 .....	2
51	800805	Screw, Hex Cap 3/8-16x3-1/2 G8 .....	1
52	633482	Blade, 18.00 Notched Air Foil .....	3
	613251	Blade, 18.0 Solid Air Foil .....	3
	● 633484	Blade, 18.00 Mulching .....	3
	633485	Blade, 18.00 Low Lift .....	3
53	513208	Washer, Spring disc .....	6
54	800340	Screw, Hex Cap 5/8-11x1 .....	3
55	603299	Roller, antiscalp .....	6
56	603602	Bushing, roller .....	6
57	800807	Screw, Hex Cap 3/8-16x4 G8 .....	6
58	603050	Bushing Spacer .....	2
59	804510	Nut, Reg Hex 5/8-18 .....	3
60	413424	Sheave w/Hub .....	3
61	800295	Screw, Hex Cap 3/8-16x1-3/4 .....	2
62	513016	Bearing .....	6
63	614213	Link, Assembly .....	2
64	323532	Housing, Spindle .....	3
65	323528	Spacer, Bearing .....	3
66	633573	Guard, Bearing-Bottom .....	3
67	808502	Ring, Snap .....	3
68	807268	Key, machine .....	3
69	413330	Shaft, Spindle .....	3
70	414335	Housing, Cutter Assembly .....	3
71	413305	Shield, Belt .....	2
72	323533	Spacer .....	3
73	634619	Housing w/Brgs, Spacer & Ring .....	3

- Requires installation of Micro-Mulch accessory for proper mulching. Mulch kit P/N MK523(52")
- ★ Replace both sides if unit is equipped with 3/16" thick washers.  
Exmark red touch up spray paint - P/N 850337



# 52" MOWER DECK

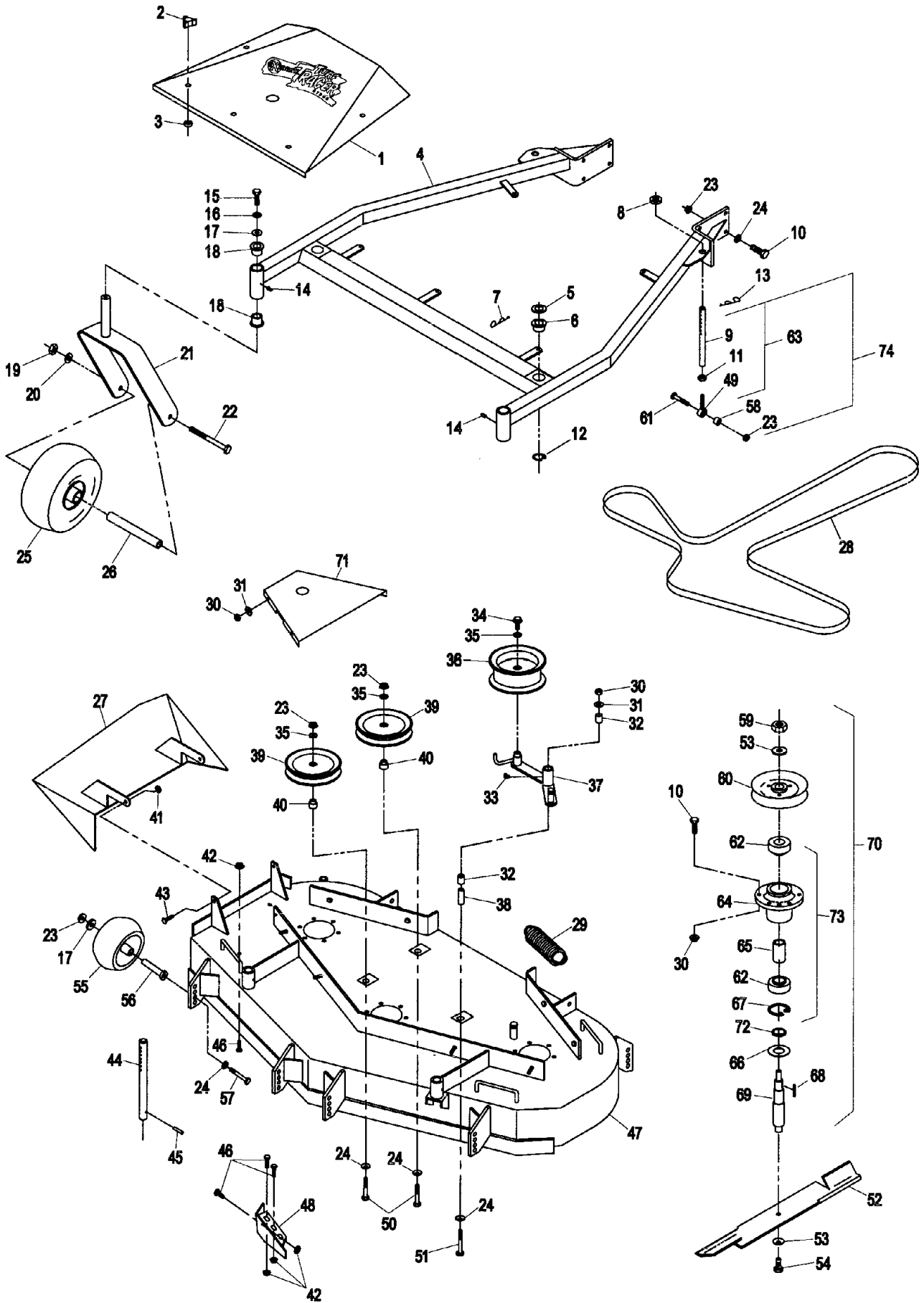

## ENGINE DECK GROUP

Ref. No.	Part No.	Description	Qty. Req'd.	Ref. No.	Part No.	Description	Qty. Req'd.
1	800297	Screw, 3/8-16 x 2-1/4 .....	2	40	603609	Bushing .....	1
2	303327	Washer, 3/8 disc spring.....	11	41	373034	Washer, pivot.....	2
	303327	Washer, 3/8 dsc spring(14 Kaw)	12	42	603610	Washer .....	2
3	603044	Bushing .....	2			(Koh, Briggs, & 17 HP Kaw)	
4	513034	Bearing, pivot .....	4	43	809080	Screw, m10x1.5x55(14HP Kaw)	1
5	811006	Zerk, straight .....	1	800819	Scrw,7/16-20x2-1/2 .....	(Koh, Briggs & 17 HP Kaw)	1
6	412285	Link weldmt, pivot.....	1	44	805259	Washer, 3/8 SAE flat .....	1
	414143	Link weldmt, pivot w/brgs .....	1	45	603843	Pulley, idler.....	1
7	800274	Screw, 5/16-18 x 1-1/4 .....	1	46	603496	Bushing - Idler .....	1
8	800254	Screw, 1/4-20 x 1 .....	2	47	603402	Spring, extension .....	1
9	809012	Nut, 1/4-20 whizlock.....	4	48	412136	Idler arm weldmt .....	1
10	523498	Spring, motion control .....	1	414141	Idler arm weldmt w/brgs.....	1	
11	513113	Spring, belt tension.....	1	49	811007	Zerk, 45 degree.....	2
12	543007	Spacer .....	1	50	800299	Screw, 3/8-16 x 2-3/4.....	1
13	213069	Washer.....	2	51	800295	Screw, 3/8-16 x 1-3/4.....	2
14	804256	Nut, 5/16-18 nylock .....	1	52	809069	Screw, #10-24 x 7/8 .....	1
15	805260	Washer, 3/8 std flat .....	2	53	323365	Chain, cold start .....	1
16	809007	Nut, 3/8-16 whizlock .....	19	54	805252	Washer, 7/32 std flat.....	1
17	413282	Linkage.....	1	55	804252	Nut, #10-24 nylock .....	1
18	806003	Hairpin cotter .....	1	56	807272	Key, 5mm sq x 25mm.....	2
19	412132	Deck weldmt, engine.....	1	57▽	803050	Setscrew,sq hd cuppoint.....	4
20	800290	Screw, 3/8-16 x 3/4 .....	2	58	413095	Belt, pump drive .....	1
21	633068	Arm.....	1	59	413010	Sheave, pump drive .....	2
22	809001	Nut, 5/16-18 whizlock .....	7	60	413096	Belt, blade clutch.....	1
	809001	Nut, 5/16-18 wzlK(Briggs&17Kaw)	11	61	807259	Key, 1/4 sq x 1 .....	2
23	303334	Washer, 5/16 disc spring.....	5	62◇	412011	Sheave w/shaft .....	1
24	322110	Guide weldmt, belt.....	1	63◇	413111	Bearing, clutch .....	2
25	809072	Screw, m8x1.25x25.....	3	64	808502	Ring, retaining .....	2
		(14hp Kaw & Koh)		65	413012	Spacer, bearing.....	1
	800275	Screw, 5/16-18x1-1/2 .....	3	66	523157	Washer, spacer.....	1
		(Briggs & 17hp Kaw)		67	413049	Plate, clutch pivot.....	1
26	809018	Screw, m8x1.25x30.....	1	68	800273	Screw, 5/16-18 x 1 .....	6
		(14hp Kaw & Koh)		69	413207	Pivot, bearing .....	2
	800276	Screw, 5/16-18x1-3/4 .....	1	70	412417	Arm weldmt, clutch.....	1
		(Briggs & 17hp Kaw)		414418	Arm weldmt, clutch w/brgs .....	1	
27	800303	Screw, 3/8-16 x 4-1/2 .....	1	71	413235	Washer, spacer.....	1
28	323366	Ring, split.....	1	72	412138	Pin weldmt, pivot.....	1
29	804257	Nut, 3/8-16 nylock .....	6	73	800271	Screw, 5/16-18 x 3/4 .....	1
30	800292	Screw, 3/8-16 x 1 .....	8	74	413062	Band, brake.....	1
31	412080	Mount, wheel motor 36".....	2	75	800294	Screw, 3/8-16 x 1 1/2 .....	2
	412082	Mount, wheel motor 48"&52" ...	2	76	412325	Guide weldmt, belt .....	1
32	803045	Screw.3/8-16 x 3/4 whizlock....	8	77◇	412031	Sheave w/drum (36" & 52").....	1
33◇	602997	Hub, four bolt w/studs.....	2	412028	Sheave w/drum (48") .....	1	
	613150	Stud .....	8	78	800521	Screw, 3/8-24 x 1 .....	1
34	603714	Wheel & tire assy .....	2	79	413009	Plate, guard.....	1
	603427	Tire 16 x 6.50-8 .....	2	80	805258	Washer, 5/16 std flat.....	2
	603715	Wheel .....	2	81◆	403124	Elbow (Briggs).....	1
35	513011	Nut, wheel 1/4-20 .....	8	82◆	543232	Nipple, pipe (Briggs) .....	1
36	803040	Nut, slotted 3/4-16.....	2	83◆	543233	Cap (Koh & Briggs).....	1
37	806800	Pin, cotter 9/64 x 1-1/2 .....	2	84◆	303431	Elbow (Koh & Briggs).....	1
38	807264	Key, 1/4sq x 2-5/8 .....	1	85◆	323326	Nipple, pipe (Koh) .....	1
39◇	413004	Sheave assy, drive .....	1				

▽ Use Pro-Lock (nut type, Part no. 840022, 5 ml tube) on setscrew threads.

◆ Use a Teflon pipe sealant or equivalent on threads.

◇ Apply anti-seize to shaft on sheave, drive sheave bore and wheel hub bore.

Exmark red touch up spray paint - P/N 850337

# ENGINE DECK GROUP

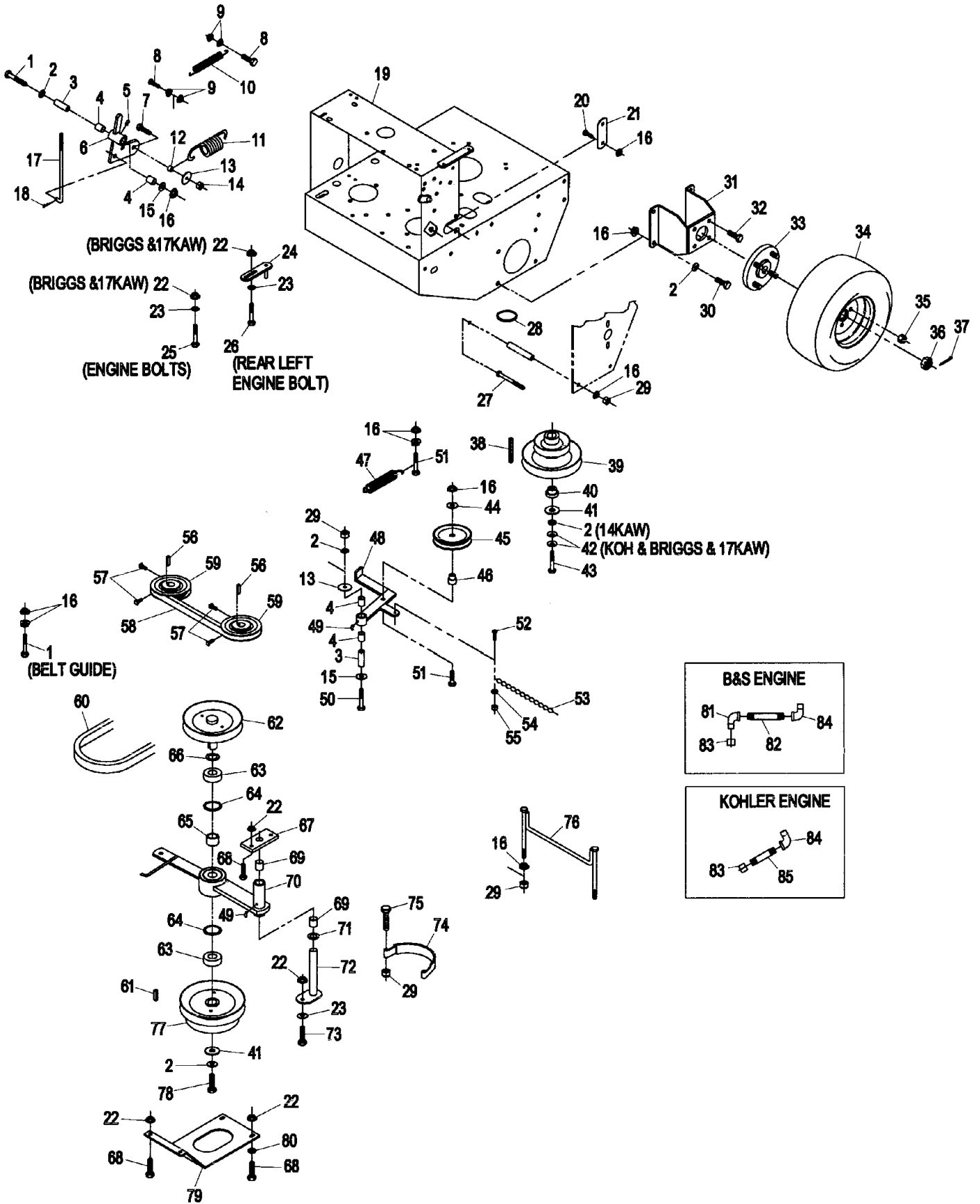

## ENGINE DECK GROUP (con't.)

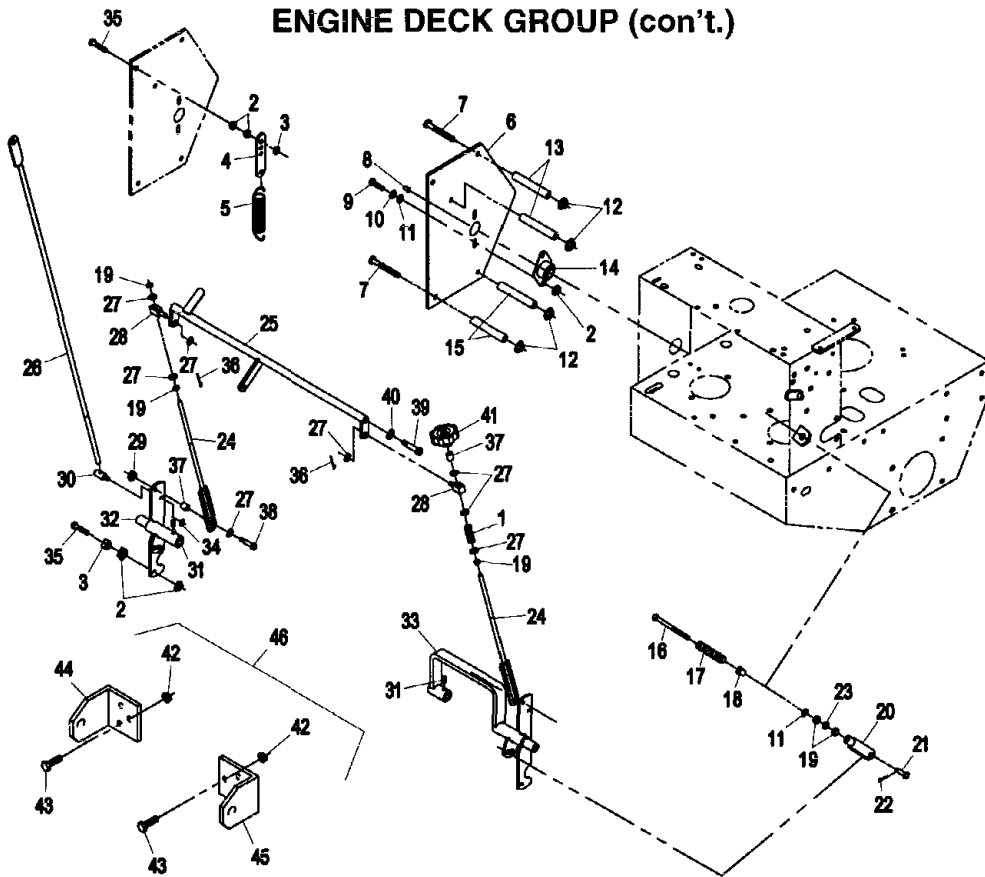

Ref. No.	Part No.	Description	Qty. Req'd.	Ref. No.	Part No.	Description	Qty. Req'd.
1	323245	Spring .....	1	25	412203	Crank weldmt .....	1
2	809001	Nut, 5/16-18 whizlock .....	12	26	413219	Rod, drive lever .....	2
3	804256	Nut, 5/16-18 nylock.....	4	27	805257	Washer, 5/16 SAE.....	9
4	613089	Tab, spring extension .....	2	28	603676	Swivel, short .....	2
5	603693	Spring, extension.....	2	29	809012	Nut, 1/4-20 whizlock .....	2
6	413201	Shield, hydro .....	2	30	413227	Swivel, drive lever.....	2
7	800302	Screw, 3/8-16 x 4.....	7	31♦	803022	Setscrew, 5/16-18x5/8.....	2
8	811006	Zerk, 1/4-28 .....	2	32	412272	Arm weldmt, LH.....	1
9	800271	Screw, 5/16-18 x 3/4.....	4	33	412270	Arm weldmt, RH .....	1
10	805005	Washer, 5/16 hvy spr lock .....	4	34	808520	Klipring.....	2
11	805256	Washer, 1/4 std flat .....	6	35	800274	Screw, 5/16-18 x 1-1/4.....	2
12	809007	Nut, 3/8-16 whizlock .....	8	36	806753	Cotter pin, 3/32 x 1/2 .....	2
13	323195	Spacer, shield.....	4	37	603903	Spacer .....	3
14	633102	Bearing, side flange .....	2	38♦	809057	Bolt, .312 x .75 hx skt hd shldr	2
15	323197	Spacer, shield.....	4	39♦	809056	Bolt,.375 x .375 hx skt hd shldr	2
16	603737	Bolt, neutral return .....	2	40	805259	Washer, 3/8 SAE flat.....	2
17	603807	Spring, neutral return.....	2	41	413151	Knob .....	1
18	603735	Bushing, nylon .....	2	42	809007	Nut, 3/8-16 whizlock .....	6
19	804521	Nut, 5/16-24 hex.....	7	43	800292	Screw, 3/8-16 x 1.....	6
20	303105	Yoke.....	2	44	413252	Bracket, sulky LH.....	1
21	808280	Clevis pin, 5/16 x 1 .....	2	45	413254	Bracket, sulky RH.....	1
22	806003	Hairpin cotter .....	2	46	411255	Sulky kit .....	1
23	804758	Nut, 5/16-24 jam.....	2	47	800016	Tap Bolt 5/16-18 x 1-1/4.....	2
24	412276	Rod, control .....	2				

♦Use Pro-Lock nut type, Part No. 840022 (.5 ml tube) on bolt & setscrew threads.

Exmark red touch up spray paint - PN 850337

# HYDRAULICS GROUP

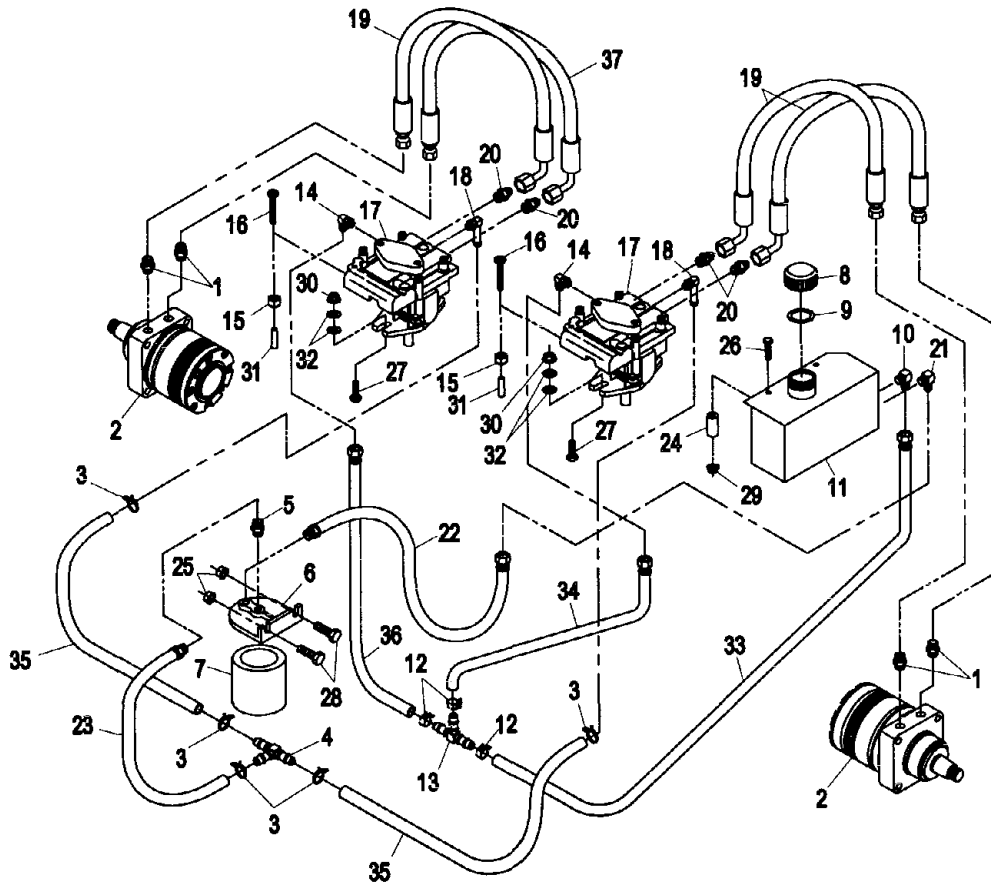

Ref. No.	Part No.	Description	Qty. Req'd.	Ref. No.	Part No.	Description	Qty. Req'd.
1	603991	Fitting, strght connector .....	4	18	603989	Elbow, 90° .....	2
	603919	Boss O-Ring .....	1		603923	O-Ring .....	1
	603992	Flare O-Ring .....	1	19	613034	Hose, high pressure .....	3
2	603718	Wheel motor .....	2	20	603990	Adapter, straight thread .....	4
	000138	Kit, Bearing .....	1		603920	Boss O-Ring .....	1
	000119	Kit, seal .....	1		603992	Flare O-Ring .....	1
3	603827	Clamp, hose (5/8) .....	5	21	603988	Elbow, 90° .....	1
4	603721	Fitting, Hose Tee (3/8 I.D hose) 1	1	22	602985	Hose, supply .....	1
5	513510	Connector, male .....	1	23	602754	Hose, charge line .....	1
6*	603720	Head, filter .....	1	24	323218	Spacer, hydraulic tank .....	2
7	513211	Element, oil filter .....	1	25	809001	Nut, whizlock 5/16-18 .....	2
∇	523541	Element, oil filter(winter) .....	1	26	800258	Screw, 1/4-20 x 2 .....	2
8	513167	Cap, hydraulic reservoir .....	1	27	800293	Screw, 3/8-16 x 1-1/4 .....	4
9	523103	Gasket, tank cap .....	1	28	800273	Screw, 5/16-18 x 1 .....	2
10	603987	Elbow, 90° .....	1	29	809012	Nut, whizlock 1/4-20 .....	2
11*	512166	Reservoir, hydraulic fluid .....	1	30	809007	Nut, whizlock 3/8-16 .....	4
12	603826	Hose Clamp 1/2 .....	3	31	613073	Grip, dump valve .....	2
13	603722	Fitting - Hose Tee(1/4 I.D hose) 1	1	32	805258	Washer, 5/16 std .....	8
14	513840	Elbow - 90° .....	2	33	602750	Hose, case drain .....	1
	603921	O-Ring .....	1	34	632286	Hose assy, lo pressure .....	1
15	804255	Nut, nylock 1/4-20 .....	2	35	413273	Hose, lo pressure .....	2
16	801063	Screw, 1/4-20 x 2 pan head ....	2	36	632285	Hose assy, lo pressure .....	1
17	613042	Pump, hydro .....	2	37	323241	Hose, high pressure .....	1

\* Use Teflon Pipe Sealant or equivalent on hydraulic reservoir and filter head fittings.

∇ Use only for operation below 32°F(0°C)

Exmark black touch up spray paint - gloss black

## UPPER HANDLES and CONTROLS

Ref. No.	Part No.	Description	Qty. Req'd.	Ref. No.	Part No.	Description	Qty. Req'd.
1	303020	Grip.....	1	45	323245	Spring, compression .....	2
2	412295	Lever weldmt, blade engage ....	1	46	805257	Washer 5/16 SAE flat.....	5
3	805260	Washer, 3/8 std flat .....	2	47	800251	Screw, 1/4-20 x 5/8 .....	2
4	800295	Screw, 3/8-16 x 1-3/4 .....	1		800251	Screw, 1/4-20 x 5/8 .....	4
5	413088	Spacer.....	1			(Briggs & 17hp Kaw)	
6	804257	Nut, 3/8-16 nylock.....	1	48	413225	Rod, speed control.....	1
7	806003	Hairpin cotter .....	5	49	804758	Nut, 5/16-24 jam.....	1
8	413293	Rod, blade engagement .....	1	50	303105	Yoke .....	1
9	413279	Turnbuckle.....	1	51	808280	Clevis pin 5/16 x 1 .....	1
10	804507	Nut, 3/8-16 hex.....	1	52	513508	Cap, fuel.....	1
11∇	412183	Lever weldmt opc LH.....	1	53	413179	Tank, fuel .....	1
12♦	803322	Setscrew, 5/16-24 x 5/16.....	2	54∇	633023	Stud, fuel tank .....	2
13	303365	Bushing, nylon .....	2	55	633349	Spring, fuel tank .....	2
14	322192	Rod weldmt, opc.....	1	56	805005	Washer, 5/16 hvy lock.....	2
15	303363	Spring, actuator .....	1	57	800271	Screw, 5/16-18 x 3/4 .....	2
16∇	412185	Lever weldmt, opc RH .....	1	58	513645	Bushing, fuel valve .....	1
17	807513	Bolt, #10-24 x 1/2 carriage ....	2	59	543277	Elbow, fuel tank.....	1
18	513592	Knob, red throttle .....	1	60	303077	Clamp, fuel line .....	4
19	323129	Throttle control (Koh & 14hp Kaw)	1			(Briggs & 17hp Kaw)	
	633696	Throttle control (Briggs).....	1		303077	Clamp, fuel line (14hp Kaw) ....	5
	413428	Throttle control (17hp Kaw) ....	1		303077	Clamp, fuel line (Koh).....	6
20	804252	Nut, #10-24 nylock.....	4	61	603955	Hose, fuel line 6" .....	1
21	412140	Handle weldmt, upper.....	1			(Koh & 14hp Kaw & 17hp Kaw)	
22	303097	Grip, handle .....	2		543649	Hose, fuel line 7" (Briggs).....	1
23	413152	Bearing .....	4	62	603770	Valve, fuel.....	1
24	412159	Lever, drive LH .....	1	63	603776	Hose, fuel line 2.5" .....	1
	412161	Lever, drive RH (shown).....	1			(14hp Kaw & Koh)	
25	603749	Bushing, drive lever.....	2		303471	Hose, fuel line 12" (Briggs).....	1
26	800256	Screw, 1/4-20 x 1-1/2 .....	2		303022	Hose, fuel line 8.5"(17hp Kaw)	1
27	809012	Nut, 1/4-20 whizlock .....	4	64	303197	Filter, fuel .....	1
28	804255	Nut, 1/4-20 Nylock .....	3	65	303471	Hose, fuel line 12" (14hp Kaw) 1	
	804255	Nut, 1/4-20 Nylock .....	5		603954	Hose, fuel line 13.75" (Koh) ....	1
		(Briggs & 17hp Kaw)		66	303308	Clamp, fuel line (14hp Kaw) ....	1
29	805256	Washer 1/4 std flat .....	3	67	403121	Switch, on/off .....	1
30	303435	Washer, 1/4 disc spr (shown).	6			(Briggs & 17hp Kaw)	
31	612168	Thumb latch w/grip RH.....	1		603511	Keys, ignition .....	1
	612167	Thumb latch w/grip LH.....	1	68	403118	Bracket, key switch .....	1
32	800257	Screw, 1/4-20 x 1-3/4 .....	2			(Briggs & 17hp Kaw)	
33	303019	Grip, latch .....	2	69	803028	Screw, #10-24 x 5/8 .....	6
34	809007	Nut, 3/8-16 whizlock .....	4	70	323229	Clip, loom .....	2
35	303327	Washer, 3/8 disc spring.....	4	71	303287	Tie, plastic.....	3
36	800292	Screw, 3/8-16 x 1.....	4	72	513051	Switch .....	3
37	613055	Pin, clevis .....	2	73	800252	Screw, 1/4-20 x 3/4 .....	1
38	800277	Screw, 5/16-18 x 2.....	2	74	633181	Plate, tapped .....	2
39	603716	Washer, friction disc.....	1	75•	413146	Harness, wiring (14hp Kaw) ...	1
40	323244	Washer, friction .....	2		413208	Harness, wiring (Koh) .....	1
41	603730	Plate, shifter lever.....	1		413323	Harness, wiring (Briggs) .....	1
42	602733	Lever weldmt, shift.....	1		413430	Harness, wiring (17hp Kaw) ...	1
43♦	603175	Knob .....	1	76	323430	Module, interlock .....	1
44	804256	Nut, 5/16-18 nylock.....	4	77	804002	Nut, Square #10-24 .....	2

♦ Use Pro-Lock nut type, Part no. 840022 (.5cc tube) on setscrew threads and on shifter knob threads.

∇ Use Pro-Lock retaining type, Part no. 840023 (.5cc tube) on inside of bore of OPC hub and on fuel tank studs.

• Use dielectric grease on all electrical connectors.

Exmark black touch up spray paint - Gloss black

# UPPER HANDLES and CONTROLS

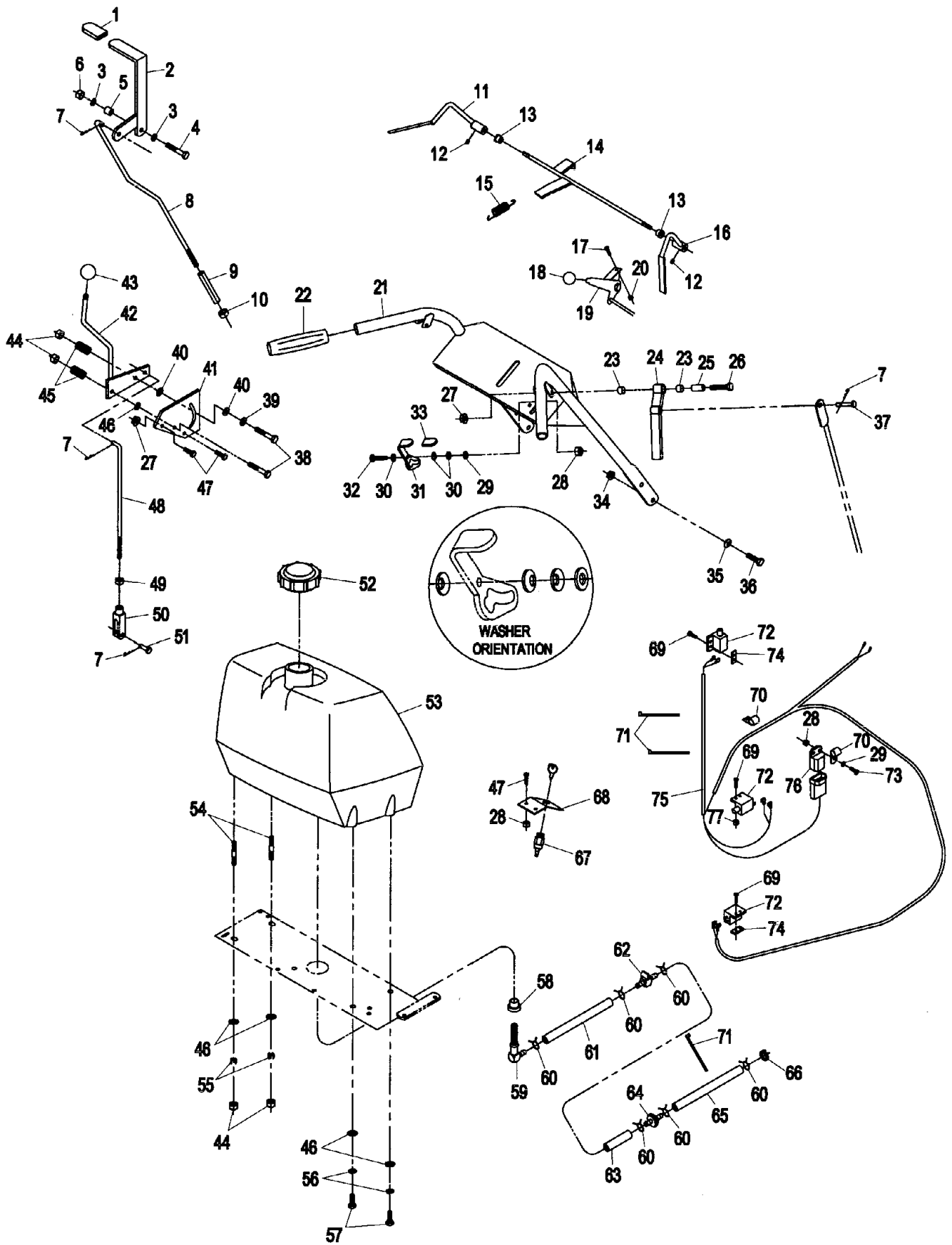

## DECALS

Ref. No.	Part No.	Description	Qty. Req'd.	Ref. No.	Part No.	Description	Qty. Req'd.
1	303100	Decal, cutter blade.....	1	16	413214	Decal, tracking .....	1
2	303102	Decal, neutral lock.....	2	17	513746	Decal, muffler.....	2
3	303293	Decal, 2 min cool.....	1	18	513890	Decal, hyd tank.....	1
4	323525	Decal, danger .....	1	19	543660	Decal, mower deck.....	1
5	303508	Decal, discharge warning .....	1	20	603845	Decal, hyd drive release.....	1
6	303517	Decal, belt drive.....	1	21	413342	Decal, swash.....	1
7	303520	Decal, trivantage.....	1	22	613049	Decal, console.....	1
8	323151	Decal, thrttle/choke(Kaw&Koh)	1	23	613169	Decal, shifter .....	1
9	323232	Decal, instructional .....	1	24	403120	Decal, off/run(Brigs & 17hp Kaw)	1
10	323411	Decal, commercial 36.....	1	25	403132	Decal, commercial 52 .....	1
11	323540	Decal, roller mounting.....	1	26	413327	Decal, belt routing (48" & 52").	1
12	403005	Decal, danger (36").....	1	27	543631	Decal, throttle (Briggs) .....	1
	403005	Decal, danger (48" & 52").....	2		323409	Decal, thrttle/choke (17hp Kaw)	1
13	403080	Decal, patent .....	1	28	403131	Decal, commercial 48 .....	1
14	403143	Decal, sulky warning.....	1	29	373066	Decal, patent pending .....	1
15	413206	Decal, belt routing (36").....	1	30	413421	Decal, indicator .....	1
					414442	Decal kit .....	



# DECALS

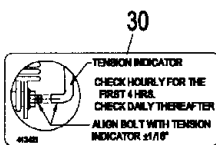
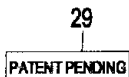
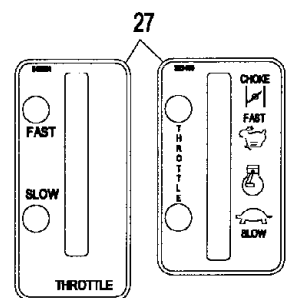
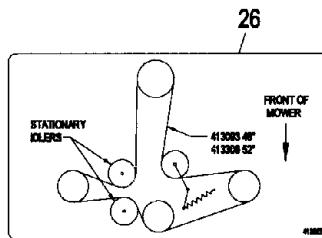
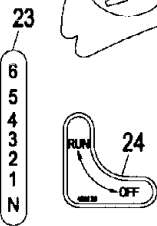
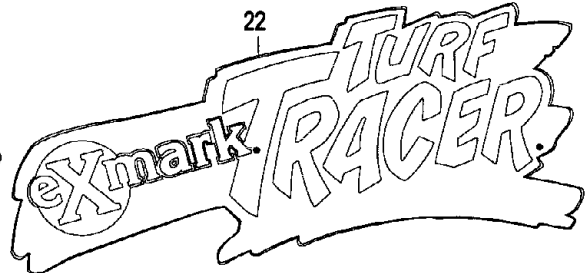
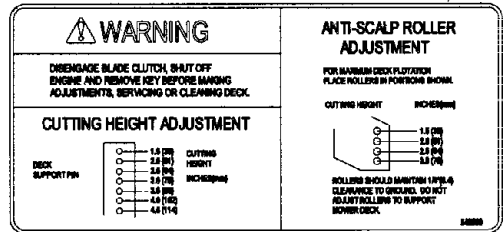
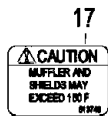
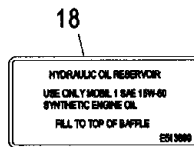
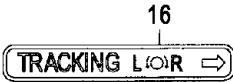
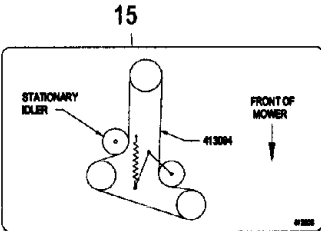
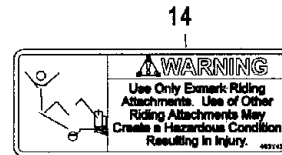
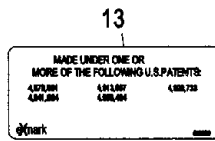
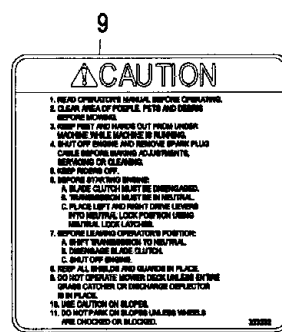
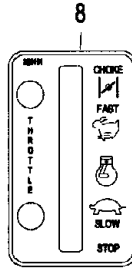
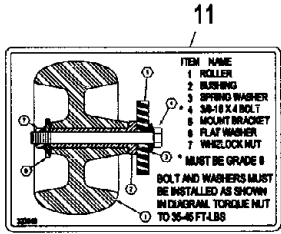
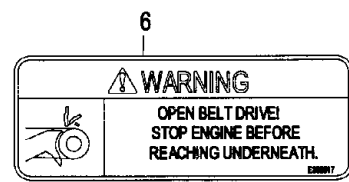
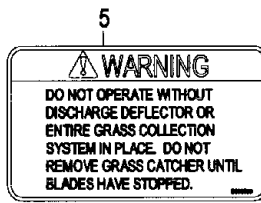
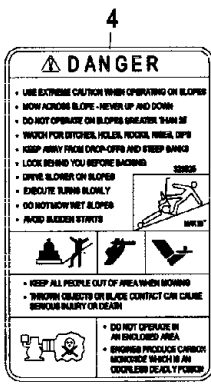
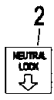
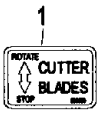

# WIRING DIAGRAMS

## B&S VANGUARD

FROM SAFETY INTERLOCK MODULE

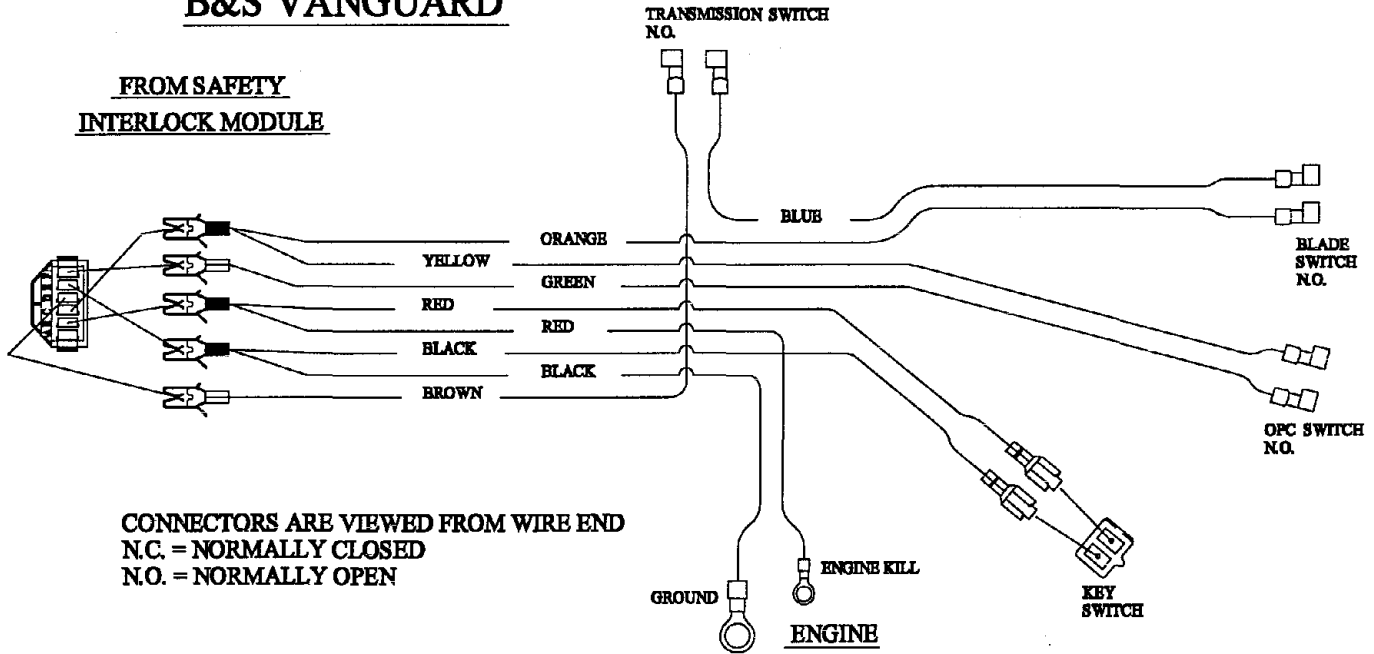

## 14 HP KAWASAKI

FROM SAFETY INTERLOCK MODULE

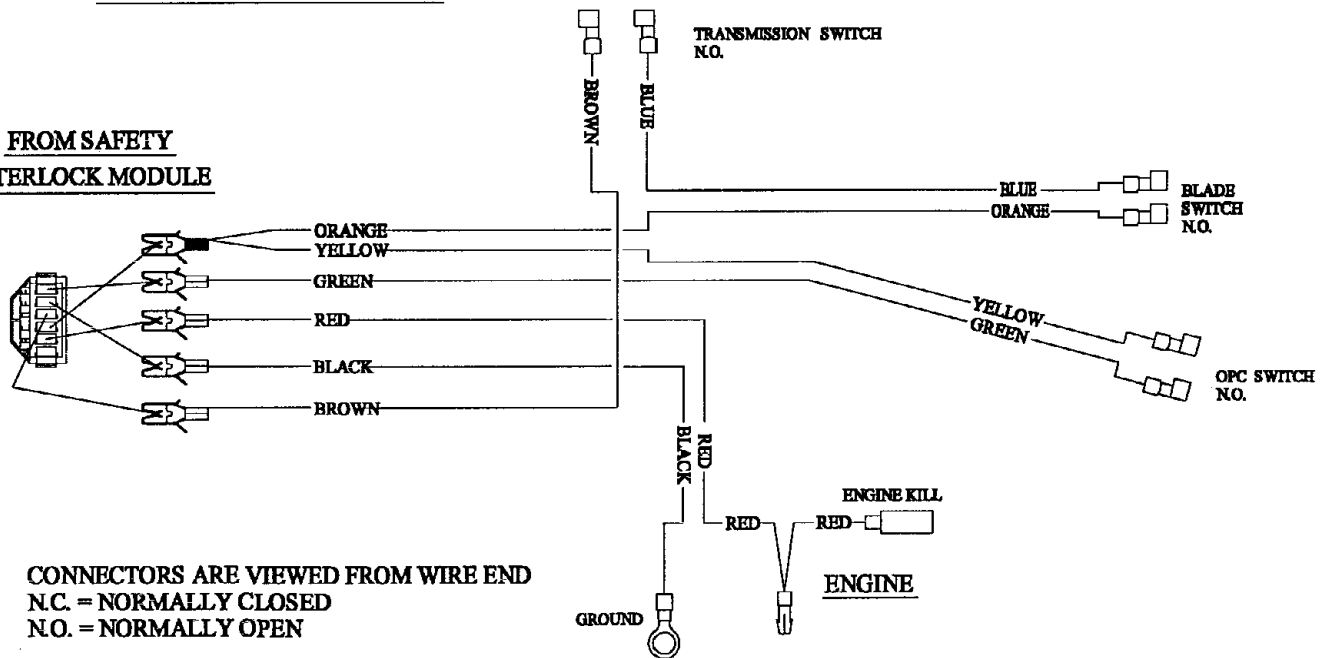

# WIRING DIAGRAMS

## KOHLER

FROM SAFETY  
INTERLOCK MODULE

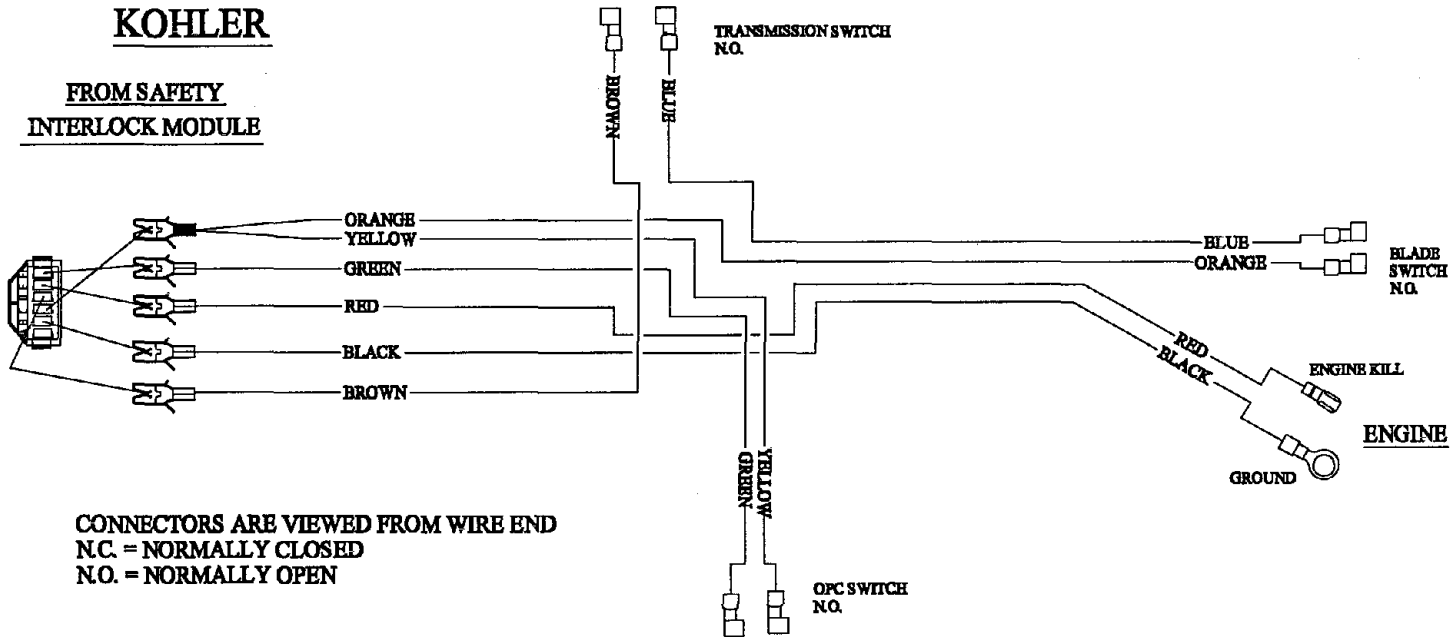

CONNECTORS ARE VIEWED FROM WIRE END  
N.C. = NORMALLY CLOSED  
N.O. = NORMALLY OPEN

## 17 HP KAWASAKI

FROM SAFETY  
INTERLOCK MODULE

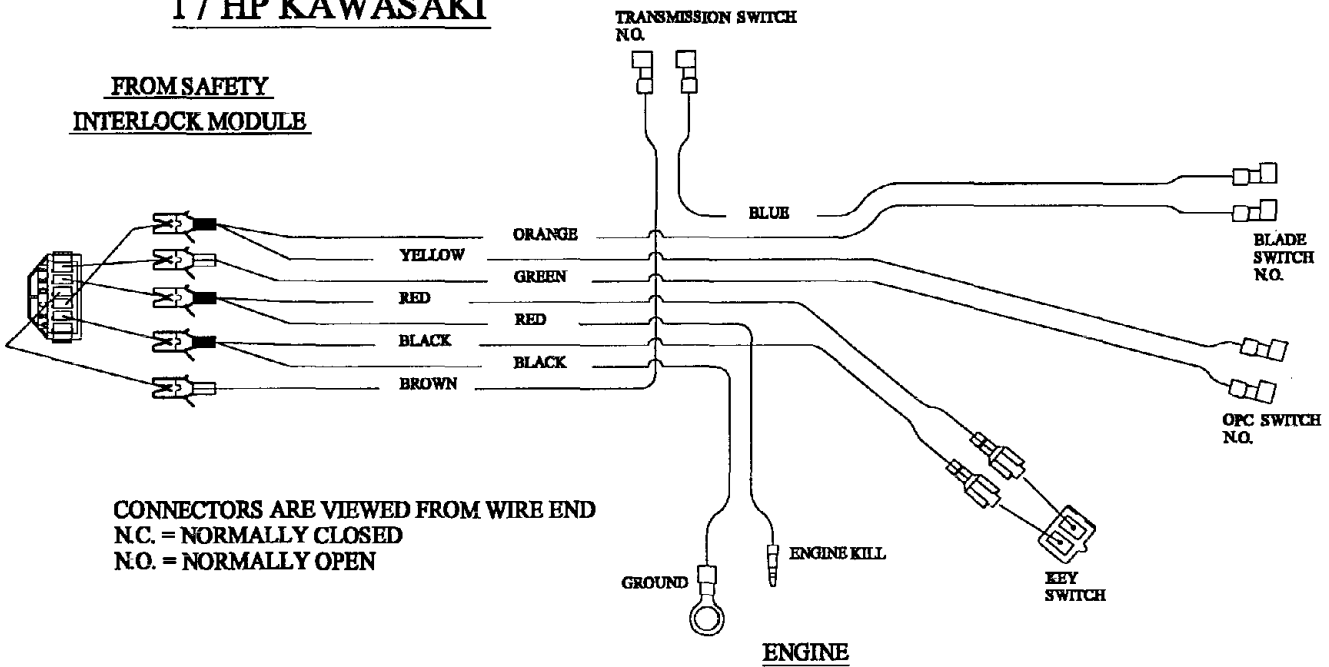

CONNECTORS ARE VIEWED FROM WIRE END  
N.C. = NORMALLY CLOSED  
N.O. = NORMALLY OPEN

**SEE EXMARK'S COMPLETE  
LINE OF PRODUCTS FOR TURF CARE**

**LAZER Z**

**LAZER Z HP**

**EXPLORER**

**TURF RANGER**

**TURF TRACER**

**TURF TRACER HP**

**VIKING HYDRO**

**METRO**

**METRO HP**

**SELF STEERING SULKY**

**GRASS CATCHER**

**MICRO-MULCHING ACCESSORY**

**EXMARK MFG. CO. INC.  
INDUSTRIAL PARK BOX 808  
BEATRICE, NE. 68310**

**PART NO. 850567  
(402) 223-6300  
FAX (402) 223-6384**

**ALL RIGHTS RESERVED**

**PRINTED IN U.S.A.**

